

H110T
H110T/CSM



Motherboard

Copyright © 2016 ASUSTeK COMPUTER INC. All Rights Reserved.

No part of this manual, including the products and software described in it, may be reproduced, transmitted, transcribed, stored in a retrieval system, or translated into any language in any form or by any means, except documentation kept by the purchaser for backup purposes, without the express written permission of ASUSTeK COMPUTER INC. ("ASUS").

Product warranty or service will not be extended if: (1) the product is repaired, modified or altered, unless such repair, modification or alteration is authorized in writing by ASUS; or (2) the serial number of the product is defaced or missing.

ASUS PROVIDES THIS MANUAL "AS IS" WITHOUT WARRANTY OF ANY KIND, EITHER EXPRESS OR IMPLIED, INCLUDING BUT NOT LIMITED TO THE IMPLIED WARRANTIES OR CONDITIONS OF MERCHANTABILITY OR FITNESS FOR A PARTICULAR PURPOSE. IN NO EVENT SHALL ASUS, ITS DIRECTORS, OFFICERS, EMPLOYEES OR AGENTS BE LIABLE FOR ANY INDIRECT, SPECIAL, INCIDENTAL, OR CONSEQUENTIAL DAMAGES (INCLUDING DAMAGES FOR LOSS OF PROFITS, LOSS OF BUSINESS, LOSS OF USE OR DATA, INTERRUPTION OF BUSINESS AND THE LIKE), EVEN IF ASUS HAS BEEN ADVISED OF THE POSSIBILITY OF SUCH DAMAGES ARISING FROM ANY DEFECT OR ERROR IN THIS MANUAL OR PRODUCT.

SPECIFICATIONS AND INFORMATION CONTAINED IN THIS MANUAL ARE FURNISHED FOR INFORMATIONAL USE ONLY, AND ARE SUBJECT TO CHANGE AT ANY TIME WITHOUT NOTICE, AND SHOULD NOT BE CONSTRUED AS A COMMITMENT BY ASUS. ASUS ASSUMES NO RESPONSIBILITY OR LIABILITY FOR ANY ERRORS OR INACCURACIES THAT MAY APPEAR IN THIS MANUAL, INCLUDING THE PRODUCTS AND SOFTWARE DESCRIBED IN IT.

Products and corporate names appearing in this manual may or may not be registered trademarks or copyrights of their respective companies, and are used only for identification or explanation and to the owners' benefit, without intent to infringe.

Offer to Provide Source Code of Certain Software

This product contains copyrighted software that is licensed under the General Public License ("GPL"), under the Lesser General Public License Version ("LGPL") and/or other Free Open Source Software Licenses. Such software in this product is distributed without any warranty to the extent permitted by the applicable law. Copies of these licenses are included in this product.

Where the applicable license entitles you to the source code of such software and/or other additional data, you may obtain it for a period of three years after our last shipment of the product, either

(1) for free by downloading it from <http://support.asus.com/download>
or

(2) for the cost of reproduction and shipment, which is dependent on the preferred carrier and the location where you want to have it shipped to, by sending a request to:

ASUSTeK Computer Inc.
Legal Compliance Dept.
15 Li Te Rd.,
Beitou, Taipei 112
Taiwan

In your request please provide the name, model number and version, as stated in the About Box of the product for which you wish to obtain the corresponding source code and your contact details so that we can coordinate the terms and cost of shipment with you.

The source code will be distributed WITHOUT ANY WARRANTY and licensed under the same license as the corresponding binary/object code.

This offer is valid to anyone in receipt of this information.

ASUSTeK is eager to duly provide complete source code as required under various Free Open Source Software licenses. If however you encounter any problems in obtaining the full corresponding source code we would be much obliged if you give us a notification to the email address gpl@asus.com, stating the product and describing the problem (please DO NOT send large attachments such as source code archives, etc. to this email address).

Contents

Safety information	iv
About this guide	iv
Package contents	vi
H110T specifications summary	vi

Chapter 1 Product introduction

Motherboard overview	1-1
Central Processing Unit (CPU)	1-8
System memory	1-9

Chapter 2 BIOS information

BIOS setup program	2-1
EZ Mode	2-2
Advanced Mode	2-3
Exit menu	2-4

Appendices

Notices	A-1
ASUS contact information	A-5

Safety information

Electrical safety

- To prevent electrical shock hazard, disconnect the power cable from the electrical outlet before relocating the system.
- When adding or removing devices to or from the system, ensure that the power cables for the devices are unplugged before the signal cables are connected. If possible, disconnect all power cables from the existing system before you add a device.
- Before connecting or removing signal cables from the motherboard, ensure that all power cables are unplugged.
- Seek professional assistance before using an adapter or extension cord. These devices could interrupt the grounding circuit.
- Ensure that your power supply is set to the correct voltage in your area. If you are not sure about the voltage of the electrical outlet you are using, contact your local power company.
- If the power supply is broken, do not try to fix it by yourself. Contact a qualified service technician or your retailer.

Operation safety

- Before installing the motherboard and adding components, carefully read all the manuals that came with the package.
- Before using the product, ensure all cables are correctly connected and the power cables are not damaged. If you detect any damage, contact your dealer immediately.
- To avoid short circuits, keep paper clips, screws, and staples away from connectors, slots, sockets and circuitry.
- Avoid dust, humidity, and temperature extremes. Do not place the product in any area where it may be exposed to moisture.
- Place the product on a stable surface.
- If you encounter technical problems with the product, contact a qualified service technician or your retailer.

About this guide

This user guide contains the information you need when installing and configuring the motherboard.

How this guide is organized

This guide contains the following parts:

- **Chapter 1: Product introduction**
This chapter describes the features of the motherboard and the new technology it supports. It includes descriptions of the switches, jumpers, and connectors on the motherboard.
- **Chapter 2: BIOS information**
This chapter discusses changing system settings through the BIOS Setup menus. Detailed descriptions for the BIOS parameters are also provided.

Where to find more information

Refer to the following sources for additional information and for product and software updates.

1. ASUS websites

The ASUS website provides updated information on ASUS hardware and software products. Refer to the ASUS contact information.

2. Optional documentation

Your product package may include optional documentation, such as warranty flyers, that may have been added by your dealer. These documents are not part of the standard package.

Conventions used in this guide

To ensure that you perform certain tasks properly, take note of the following symbols used throughout this manual.



DANGER/WARNING: Information to prevent injury to yourself when completing a task.



CAUTION: Information to prevent damage to the components when completing a task.



IMPORTANT: Instructions that you **MUST** follow to complete a task.



NOTE: Tips and additional information to help you complete a task.

Typography

Bold text

Indicates a menu or an item to select.

Italics

Used to emphasize a word or a phrase.

<Key>

Keys enclosed in the less-than and greater-than sign means that you must press the enclosed key.

Example: <Enter> means that you must press the Enter or Return key.

<Key1> + <Key2> + <Key3>

If you must press two or more keys simultaneously, the key names are linked with a plus sign (+).

Package contents

Check your motherboard package for the following items.

Motherboard	ASUS H110T motherboard
Cables	2 x Serial ATA 6.0 Gb/s cables 1 x SATA power cable
Accessories	2 x I/O Shields (1 x mini-ITX, 1 x thin mini-ITX) 2 x M.2 screw packages
Application DVD	1 x Support DVD
Documentation	User Guide



If any of the above items is damaged or missing, contact your retailer.

H110T specifications summary

Specifications	
CPU	<p>LGA1151 socket for 6th Generation Intel® Core™ i7 / i5 / i3, Pentium®, and Celeron® processors</p> <p>Supports Intel® 14nm CPU*</p> <p>Supports Intel® Turbo Boost Technology 2.0**</p> <p>* Supports up to 65W CPU for Intel® standard thin mini-ITX heatsink. Supports up to 95W CPU for Intel® standard LGA1151 heatsink.</p> <p>** The Intel® Turbo Boost Technology 2.0 support depends on the CPU types.</p> <p>*** Refer to www.asus.com for Intel® CPU support list.</p>
Chipset	Intel® H110T Chipset
Memory	<p>2 x SO-DIMM maximum 32 GB*, DDR4 2133 MHz, non-ECC, un-buffered memory</p> <p>Dual-channel memory architecture</p> <p>* Refer to www.asus.com or this user manual for the Memory QVL (Qualified Vendors List).</p>
Expansion slots	1 x M.2 E key type 2230 for WIFI device
Graphics	<p>Integrated graphics processor</p> <p>Multi-VGA output support: DP, HDMI, LVDS</p> <ul style="list-style-type: none"> - Supports HDMI with maximum resolution of 4096 x 2160 @ 24Hz / 2560 x 1600 @ 60Hz - Supports LVDS with maximum resolution of 1920 x 1200 @ 60Hz - Supports DisplayPort with maximum resolution of 4096 x 2304 @ 60Hz <p>Maximum shared memory of 1024 MB</p>
Storage	<p>Intel® H110T Express Chipset</p> <ul style="list-style-type: none"> - 2 x SATA 6.0 Gb/s connectors - 1 x M.2 Socket 3, with M key, type 2242/2260 storage devices support (both SATA & PCIe mode)
LAN	<p>Realtek® 8111H, Gigabit LAN Controller</p> <p>Intel® I219V Gigabit LAN Controller</p>
Audio	<p>Realtek® ALC887-VD 4+4-channel High Definition Audio CODEC</p> <ul style="list-style-type: none"> - Supports jack-detection, Multi-streaming, Front Panel Retasking

(continued on the next page)

H110T specifications summary

Specifications	
USB	<ul style="list-style-type: none"> - 4 x USB 3.0 / 2.0 ports (4 ports at the rear panel) - 5 x USB 2.0 / 1.1 ports (5 ports at mid-board)
ASUS unique features	<p>Proven Quality</p> <p>ASUS 5X PROTECTION II</p> <ul style="list-style-type: none"> - ASUS LANGuard - Protects against LAN surges, lightning strikes and static-electricity discharges - ASUS Overvoltage Protection - World-class circuit-protection power design - ASUS DIGI+ VRM - Digital power design - ASUS DRAM Overcurrent Protection - Enhanced DRAM overcurrent protection - ASUS Stainless Steel Back I/O - 3X corrosion-resistance for greater durability <p>Superb Performance</p> <p>M.2 onboard</p> <ul style="list-style-type: none"> - The latest transfer technologies with up to 20Gb/s data transfer speed <p>ASUS Fan Xpert</p> <ul style="list-style-type: none"> - Ultimate cooling and quietness <p>UEFI BIOS</p> <ul style="list-style-type: none"> - Most advanced options with fast response time <p>One Stop Control</p> <p>AI Suite 3</p> <p>Push Notice</p> <ul style="list-style-type: none"> - Monitor your PC status with smart devices in real time <p>Mobo Connect</p> <p>Media Streamer</p> <ul style="list-style-type: none"> - Pipe music or movies from your PC to a smart TV - Media Streamer app for portable smartphone/tablet, supporting iOS7 and Android 4.0 system <p>100% All High-quality Conductive Polymer Capacitors</p>
Rear panel I/O ports	<ul style="list-style-type: none"> 1 x DC power connector* 1 x HDMI port 1 x DP port 4 x USB 3.0/2.0 ports 2 x Gigabit LAN (RJ-45) ports 2 x Audio jacks <p>* Supports both 19V and 12V DC input.</p>
Internal connectors	<ul style="list-style-type: none"> 2 x USB 2.0/1.1 2-port connectors support additional 4 USB 2.0/1.1 ports 1 x USB 2.0/1.1 1-port connector supports additional 1 USB 2.0/1.1 port 1 x LVDS connector 2 x SATA 6.0Gb/s connectors 1 x M.2 Socket 3, with M key, type 2242/2260 storage devices support (both SATA & PCIE mode) 1 x M.2 E key type 2230

(continued on the next page)

H110T specifications summary

Specifications	
Internal connectors	1 x CPU Fan connector
	1 x Chassis Fan connector
	1 x Front panel audio connector (AAFP)
	1 x System Panel connector
	1 x Clear CMOS jumper
	1 x COM header
	1 x TPM header
	1 x Chassis intrusion connector
	1 x SATA power connector
	1 x Speaker connector
	Connectors for AIO System
	1 x 2-pin internal DC power connector
	1 x Stereo speaker connector
1 x DMIC header	
Connectors for Flat Panel Display	
1 x Display panel backlight power selector	
1 x Flat panel display brightness connector	
1 x Display panel VCC power selector	
1 x LCD panel monitor switch header	
BIOS features	128 Mb Flash ROM, AMI BIOS, PnP, DMI3.0, WfM2.0, SM BIOS 3.0, ACPI 5.0, Multi-language BIOS, ASUS EZ Flash 3, ASUS CrashFree BIOS 3, F12 PrintScreen, F6 Qfan Control
Manageability	WfM 2.0, DMI 3.0, WOL by PME
Support DVD	Drivers
	ASUS utilities
	EZ Update
	Anti-virus software (OEM version)
OS support	Windows® 10 *
	Windows® 8.1*
	Windows® 7
	* 64-bit supported only
Form factor	Thin Mini-ITX Form Factor, 6.7 in x 6.7 in (17.0 cm x 17.0 cm)



Specifications are subject to change without notice.

Product introduction

Motherboard overview

1



- Unplug the power cord from the wall socket before touching any component.
- Before handling components, use a grounded wrist strap or touch a safely grounded object or a metal object, such as the power supply case, to avoid damaging them due to static electricity.
- Before you install or remove any component, ensure that the ATX power supply is switched off or the power cord is detached from the power supply. Failure to do so may cause severe damage to the motherboard, peripherals, or components.
- Unplug the power cord before installing or removing the motherboard. Failure to do so can cause you physical injury and damage to motherboard components.

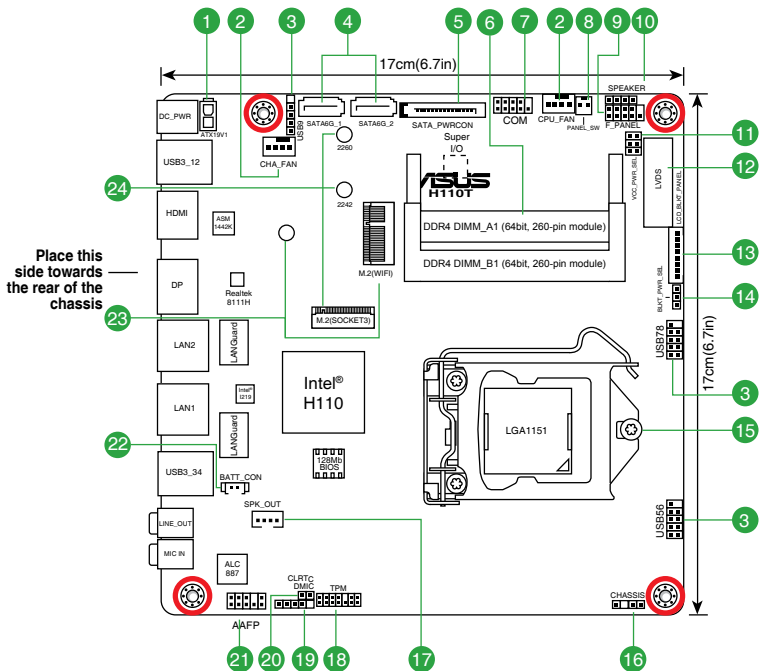

Scan the QR code to get the detailed pin definitions.

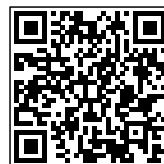

1 Internal DC power connector (2-pin ATX19V/12V)

This connector is for an ATX power supply. The plug from the power supply is designed to fit this connector in only one orientation. Find the proper orientation and push down firmly until the connector completely fits.

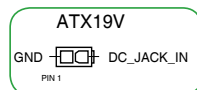

This connector supports 12V and 19V by models. Refer to the specification sheet of the model for details.

2 CPU and chassis fan connectors (4-pin CPU_FAN, 4-pin CHA_FAN)

Connect the fan cables to the fan connectors on the motherboard, ensuring that the black wire of each cable matches the ground pin of the connector.



Do not forget to connect the fan cables to the fan connectors. Insufficient air flow inside the system may damage the motherboard components. These are not jumpers! Do not place jumper caps on the fan connectors! The CPU_FAN connector supports a CPU fan of maximum 1A (12 W) fan power.

3 USB 2.0 connectors

Connect the USB module cable to these connectors, then install the module to a slot opening at the back of the system chassis. These USB connectors comply with USB 2.0 specifications and support up to 480Mbps connection speed.

4 Serial ATA 6.0Gb/s connectors (SATA6G_1/2)

These connectors connect to Serial ATA 6.0 Gb/s hard disk drives via Serial ATA 6.0 Gb/s signal cables.

5 SATA power connector (15-pin SATA_PWRCON)

This connector is for the SATA power cable. The power cable plug is designed to fit this connector in only one orientation. Find the proper orientation and push down firmly until the connector completely fit. To provide power to your SATA device, connect the SATA power cable to this connector

6 DDR4 DIMM slots

Install 2 GB, 4 GB, 8 GB, and 16 GB non-ECC un-buffered DDR4 DIMMs into these DIMM sockets.

7 Serial port connector (10-1 pin COM)

Connect the serial port module cable to this connector, then install the module to a slot opening at the back of the system chassis.

8 LCD panel monitor switch header (2-pin PANEL_SW)

This 2-pin header is for connecting a monitor switch that can turn off the LCD panel display backlight.

9 System panel connector (10-1 pin PANEL)

This connector supports several chassis-mounted functions.

10 Speaker connector (4-pin SPEAKER)

This 4-pin connector is for the chassis-mounted system warning speaker. The speaker allows you to hear system beeps and warnings.

11 Display panel VCC power selector (VCC_PWR_SEL)

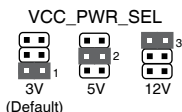

Pins	Setting
1 (Default)	3V
2	5V
3	12V

12 LVDS connector

This connector is for an LCD monitor that supports Low-voltage Differential Signaling (LVDS) interface.

13 Flat panel display brightness connector (8-pin LCD_BLK_PANEL)

This connector is for the LCD panel backlight and brightness controls. It enables the LCD panel backlight, provides backlight control signals, and provides brightness control signals for the brightness button on the front panel.

14 Display panel backlight power selector (3-pin BLKT_PWR_SEL)

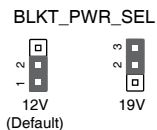

Pins	Setting
1-2 (Default)	12V
2-3	19V

15 Intel® LGA1151 CPU socket

Install Intel® LGA1151 CPU into this surface mount LGA1151 socket, which is designed for 6th Generation Intel® Core™ i7 / i5 / i3, Pentium®, and Celeron® processors



For more details, refer to **Central Processing Unit (CPU)**.

16 Chassis intrusion header (4-1 pin CHASSIS)

This header is for a chassis-mounted intrusion detection sensor or switch. Connect one end of the chassis intrusion sensor or switch cable to this header. The chassis intrusion sensor or switch sends a high-level signal to this header when a chassis component is removed or replaced. The signal is then generated as a chassis intrusion event.

By default, the pin labeled “Chassis Signal” and “Ground” are shorted with a jumper cap. Remove the jumper caps only when you intend to use the chassis intrusion detection feature.

17

Internal stereo speaker header (4-pin SPK_OUT)

The internal mono speaker header allows connection to an internal, low-power speaker for basic system sound capability. The subsystem is capable of driving a speaker load of 4 Ohms at 3 Watts (rms).

18

TPM connector (14-1 pin TPM)

This connector supports a Trusted Platform Module (TPM) system, which can securely store keys, digital certificates, passwords and data. A TPM system also helps enhance network security, protects digital identities, and ensures platform integrity.

19

DMIC connector (5-1-pin DMIC)

The DMIC connector is for connecting the digital microphone module used in All-in-One chassis.

20

Clear RTC RAM (2-pin CLRTC)

This header allows you to clear the CMOS RTC RAM data of the system setup information such as date, time, and system passwords.

To erase the RTC RAM:

1. Turn OFF the computer and unplug the power cord.
2. Use a metal object such as a screwdriver to short the two pins.
3. Plug the power cord and turn ON the computer.
4. Hold down the key during the boot process and enter BIOS setup to re-enter data.

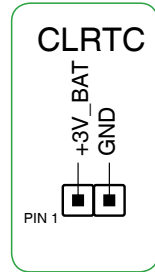

If the steps above do not help, remove the onboard battery and short the two pins again to clear the CMOS RTC RAM data. After clearing the CMOS, reinstall the battery.

21

Front panel audio connector (10-1 pin AAFP)

This connector is for a chassis-mounted front panel audio I/O module that supports HD Audio. Connect one end of the front panel audio I/O module cable to this connector.



We recommend that you connect a high-definition front panel audio module to this connector to avail of the motherboard's high-definition audio capability

22

RTC Battery header (2-pin BATT_CON)

This connector is for the lithium CMOS battery.

23**M.2 WIFI**

This socket connects to an M.2 WI-FI device. Use the bundled screw 3020-01810100 to secure your M.2 device.

24**M.2 socket 3**

This socket allows you to install an M.2 (NGFF) SSD module. Use the bundled screw 13020-0181000 to secure your M.2 device.



This socket supports M Key and 2242/2260 storage devices.

IRQ assignments for this motherboard

	A	B	C	D	E	F	G	H
HD Audio Controller	shared	-	-	-	-	-	-	-
XHCI	shared	-	-	-	-	-	-	-
SATA Controller	shared	-	-	-	-	-	-	-
Realtek LAN Controller	-	shared	-	-	-	-	-	-
Intel Lan	shared	-	-	-	-	-	-	-
M.2	shared	-	-	-	-	-	-	-
IGD	shared	-	-	-	-	-	-	-
WLAN	shared	-	-	-	-	-	-	-



When using PCI cards on shared slots, ensure that the drivers support "Share IRQ" or that the cards do not need IRQ assignments. Otherwise, conflicts will arise between the two PCI groups, making the system unstable and the card inoperable.

Rear panel connectors

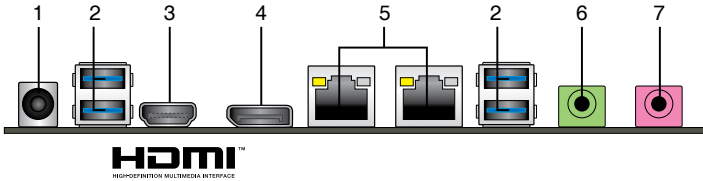

1. **DC power connector.** Insert the power adapter into this port.



- It can support both 19V and 12V DC input.
- The power adapter is purchased separately.



- Use the appropriate DC power adapter for the following scenarios:
 - Use a 90W adapter when a 35W CPU is installed on the system.
 - Use a 120W adapter when using your system with an LVDS panel.
 - Use a high-rated adapter (above 90W) when a high-rated CPU (45W or higher CPU) is installed on the system.

2. **USB 3.0 ports.** These 9-pin Universal Serial Bus (USB) ports are for USB 3.0 / 2.0 devices.



- USB 3.0 devices can only be used for data storage.
- We strongly recommend that you connect USB 3.0 devices to USB 3.0 ports for faster and better performance from your USB 3.0 devices.
- Due to the design of the Intel® 100 series chipset, all USB devices connected to the USB 2.0 and USB 3.0 ports are controlled by the xHCI controller. Some legacy USB devices must update their firmware for better compatibility.

3. **HDMI port.** This port is for a High-Definition Multimedia Interface (HDMI) connector, and is HDCP compliant allowing playback of HD DVD, Blu-Ray, and other protected content.

4. **DisplayPort.** This port is for DisplayPort-compatible devices.

5. **LAN (RJ-45) port.** This port allows Gigabit connection to a Local Area Network (LAN) through a network hub.

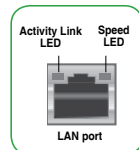

LAN port LED indications

Activity/Link LED		Speed LED	
Status	Description	Status	Description
Off	No link	OFF	10Mbps connection
Orange	Linked	ORANGE	100Mbps connection
Orange (Blinking)	Data activity	GREEN	1Gbps connection
Orange (Blinking then steady)	Ready to wake up from S5 mode	–	–

- Line Out port (lime).** This port connects to a headphone or a speaker.
- Microphone port (pink).** This port connects to a microphone.

Audio 2.1, 4.1, 5.1, or 7.1-channel configuration

Port	Headset 2.1-channel	4.1-channel	5.1-channel	7.1-channel
Line Out (Rear panel)	Front Speaker Out	Front Speaker Out	Front Speaker Out	Front Speaker Out
MIC(Rear panel)	MIC	Rear Speaker Out	Rear Speaker Out	Rear Speaker Out
Headphone (Front panel)	Headphone	Headphone	Center/Subwoofer Speaker Out	Center/Subwoofer Speaker Out
MIC (Front panel)	MIC	MIC	MIC	Side Speaker Out

Central Processing Unit (CPU)

This motherboard comes with a surface mount LGA1151 socket designed for 6th Generation Intel® Core™ i7 / i5 / i3, Pentium®, and Celeron® processors

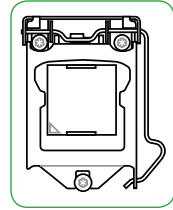

Unplug all power cables before installing the CPU.



- Ensure that you install the correct CPU designed for the LGA1151 socket only. DO NOT install a CPU designed for LGA1150, LGA1155 and LGA1156 sockets on the LGA1151 socket.
- Upon purchase of the motherboard, ensure that the PnP cap is on the socket and the socket contacts are not bent. Contact your retailer immediately if the PnP cap is missing, or if you see any damage to the PnP cap/socket contacts/motherboard components.
- Keep the cap after installing the motherboard. ASUS will process Return Merchandise Authorization (RMA) requests only if the motherboard comes with the cap on the LGA1151 socket.
- The product warranty does not cover damage to the socket contacts resulting from incorrect CPU installation/removal, or misplacement/loss/incorrect removal of the PnP cap.

Installing the CPU

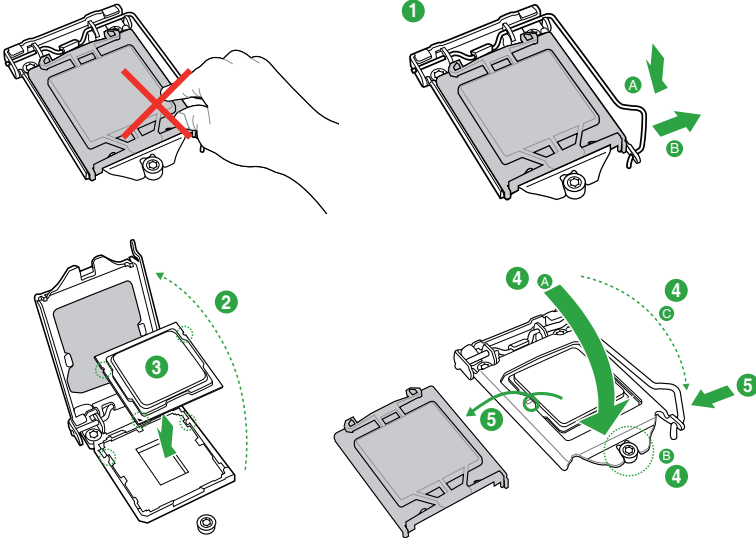

Apply the Thermal Interface Material to the CPU heatsink and CPU before you install the heatsink and fan if necessary.

System memory

Overview

This motherboard comes with two Double Data Rate 4 (DDR4) Small Outline Dual Inline Memory Module (SO-DIMM) sockets. The figure illustrates the location of the DDR4 DIMM sockets:

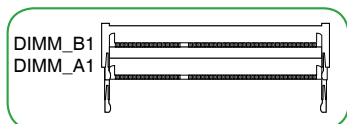

Channel	Sockets
Channel A	DIMM_A1
Channel B	DIMM_B1



- You may install varying memory sizes in Channel A and Channel B. The system maps the total size of the lower-sized channel for the dual-channel configuration. Any excess memory from the higher-sized channel is then mapped for single-channel operation.
- Always install the DIMMS with the same CAS Latency. For an optimum compatibility, we recommend that you install memory modules of the same version or data code (D/C) from the same vendor. Check with the vendor to get the correct memory modules.
- Always install a DIMM into the DIMM_A1 slot for the motherboard to work properly.
- This motherboard supports 1.2V DDR4 DIMMs.
- Due to the memory address limitation on 32-bit Windows® OS, when you install 4GB or more memory on the motherboard, the actual usable memory for the OS can be about 3GB or less. For effective use of memory, we recommend that you do any of the following:
 - Use a maximum of 3 GB system memory if you are using a 32-bit Windows® OS.
 - Install a 64-bit Windows® OS if you want to install 4GB or more on the motherboard.
 - For more details, refer to the Microsoft® support site at <http://support.microsoft.com/kb/929605/en-us>.



Visit the ASUS website at www.asus.com for the latest QVL.

Installing a DIMM

To install a DIMM

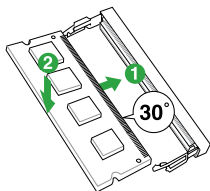

To remove a DIMM

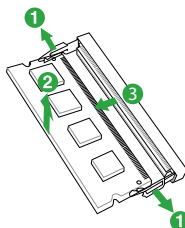

BIOS information

2



- Scan the QR code to view the BIOS update guide.
- Before using the ASUS CrashFree BIOS 3 utility, rename the BIOS file in the removable device into **H110T.CAP**.

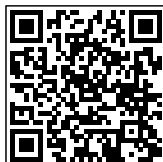

BIOS setup program

Use the BIOS Setup program to update the BIOS or configure its parameters. The BIOS screens include navigation keys and brief online help to guide you in using the BIOS Setup program.

Entering BIOS Setup at startup

To enter BIOS Setup at startup:

Press <Delete> or <F2> during the Power-On Self Test (POST). If you do not press <Delete> or <F2>, POST continues with its routines.

Entering BIOS Setup after POST

To enter BIOS Setup after POST:

- Press <Ctrl>+<Alt>+ simultaneously.
- Press the reset button on the system chassis.
- Press the power button to turn the system off then back on. Do this option only if you failed to enter BIOS Setup using the first two options.



Using the power button, reset button, or the <Ctrl>+<Alt>+ keys to force reset from a running operating system can cause damage to your data or system. We recommend you always shut down the system properly from the operating system.



- The BIOS setup screens shown in this section are for reference purposes only, and may not exactly match what you see on your screen.
- Visit the ASUS website at www.asus.com to download the latest BIOS file for this motherboard.
- If the system becomes unstable after changing any BIOS setting, load the default settings to ensure system compatibility and stability. Select the **Load Optimized Defaults** item under the Exit menu or press hotkey F5.
- If the system fails to boot after changing any BIOS setting, try to clear the CMOS and reset the motherboard to the default value. See section **Motherboard overview** for information on how to erase the RTC RAM.

BIOS menu screen

The BIOS setup program can be used under two modes: **EZ Mode** and **Advanced Mode**. Press <F7> to change between the two modes.

EZ Mode

By default, the EZ Mode screen appears when you enter the BIOS setup program. The EZ Mode provides you an overview of the basic system information, and allows you to select the display language, system performance mode, fan profile and boot device priority. To access the Advanced Mode, click **Advanced Mode(F7)** or press <F7>.



The default screen for entering the BIOS setup program can be changed. Refer to the **Setup Mode** item in **Boot menu** for details.

Displays the CPU/motherboard temperature, CPU voltage output, CPU/chassis fan speed, and SATA information

Selects the display language of the BIOS setup program

Displays the system properties of the selected mode. Click <Enter> to switch EZ System Tuning modes

Displays the CPU Fan's speed. Click the button to manually tune the fans
Loads optimized default settings

Saves the changes and resets the system

Shows the bootable devices

Displays the Advanced mode menus
Search on FAQs
Selects the boot device priority



The boot device options vary depending on the devices you installed to the system.

Advanced Mode

The Advanced Mode provides advanced options for experienced end-users to configure the BIOS settings. The figure below shows an example of the **Advanced Mode**. Refer to the following sections for the detailed configurations.



To access the EZ Mode, click **EzMode(F7)** or press <F7>.

The screenshot shows the ASUS UEFI BIOS Utility in Advanced Mode. The interface is dark-themed with blue accents. At the top, there is a menu bar with options: My Favorites, Main, **AI Tweaker**, Advanced, Monitor, Boot, Tool, and Exit. The AI Tweaker section is active, showing various CPU and DRAM settings. On the right, there is a Hardware Monitor section displaying real-time system data.

Labels and their corresponding components in the BIOS interface:

- Menu bar:** Points to the top navigation tabs.
- Language:** Points to the language selection icon.
- MyFavorite:** Points to the 'My Favorites' tab.
- Q-Fan control:** Points to the 'Q Fan Control(F6)' icon.
- Quick Note:** Points to the 'Quick Note(F9)' icon.
- Hot Keys:** Points to the 'Hot Keys' icon.
- Scroll bar:** Points to the vertical scrollbar on the right side.
- Sub-menu item:** Points to expandable sections like 'DRAM Timing Control'.
- Menu items:** Points to individual settings like 'CPU Core Ratio'.
- General help:** Points to the information icon (i) next to a setting.
- Configuration fields:** Points to the dropdown menus for settings like 'CPU Core Ratio'.
- Popup window:** Points to the expanded dropdown menu for 'CPU Core Ratio'.
- Last modified settings:** Points to the 'Last Modified' status at the bottom.
- Goes back to EZ Mode:** Points to the 'EzMode(F7)' button.
- Search on FAQs:** Points to the 'Search on FAQ' input field.
- Displays the CPU/motherboard temperature, CPU and memory voltage output:** Points to the 'Hardware Monitor' section.

Search on FAQ

Move your mouse over this button to show a QR code. Scan this QR code with your mobile device to connect to the ASUS BIOS FAQ web page. You can also scan the QR code below.



Exit menu

The Exit menu items allow you to load the optimal default values for the BIOS items, and save or discard your changes to the BIOS items.

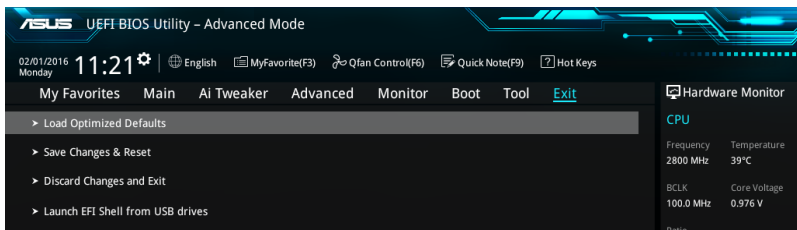

Restore Defaults

This option allows you restore or load the default values for all the setup options. When you select this option and press <ENTER>, a confirmation window appears. Select Yes to apply the default values or press <Esc> to exit.

Save Changes & Reset

Once you are finished making your selections, choose this option from the Exit menu to ensure the values you selected are saved. When you select this option or if you press <F10>, a confirmation window appears. Select OK to save changes and exit.

Discard Changes and Exit

This option allows you to exit the Setup program without saving your changes. When you select this option or if you press <Esc>, a confirmation window appears. Select OK to discard changes and exit.

Launch EFI Shell from USB drives

This option allows you to attempt to launch the EFI Shell application (shellx64.efi) from one of the available USB devices.

Appendices

Notices

Federal Communications Commission Statement

This device complies with Part 15 of the FCC Rules. Operation is subject to the following two conditions:

- This device may not cause harmful interference.
- This device must accept any interference received including interference that may cause undesired operation.

This equipment has been tested and found to comply with the limits for a Class B digital device, pursuant to Part 15 of the FCC Rules. These limits are designed to provide reasonable protection against harmful interference in a residential installation. This equipment generates, uses and can radiate radio frequency energy and, if not installed and used in accordance with manufacturer's instructions, may cause harmful interference to radio communications. However, there is no guarantee that interference will not occur in a particular installation. If this equipment does cause harmful interference to radio or television reception, which can be determined by turning the equipment off and on, the user is encouraged to try to correct the interference by one or more of the following measures:

- Reorient or relocate the receiving antenna.
- Increase the separation between the equipment and receiver.
- Connect the equipment to an outlet on a circuit different from that to which the receiver is connected.
- Consult the dealer or an experienced radio/TV technician for help.



The use of shielded cables for connection of the monitor to the graphics card is required to assure compliance with FCC regulations. Changes or modifications to this unit not expressly approved by the party responsible for compliance could void the user's authority to operate this equipment.

IC: Canadian Compliance Statement

Complies with the Canadian ICES-003 Class B specifications. This device complies with RSS 210 of Industry Canada. This Class B device meets all the requirements of the Canadian interference-causing equipment regulations.

This device complies with Industry Canada license exempt RSS standard(s). Operation is subject to the following two conditions: (1) this device may not cause interference, and (2) this device must accept any interference, including interference that may cause undesired operation of the device.

Cet appareil numérique de la Classe B est conforme à la norme NMB-003 du Canada. Cet appareil numérique de la Classe B respecte toutes les exigences du Règlement sur le matériel brouilleur du Canada.

Cet appareil est conforme aux normes CNR exemptes de licence d'Industrie Canada. Le fonctionnement est soumis aux deux conditions suivantes :

- (1) cet appareil ne doit pas provoquer d'interférences et
- (2) cet appareil doit accepter toute interférence, y compris celles susceptibles de provoquer un fonctionnement non souhaité de l'appareil.

Canadian Department of Communications Statement

This digital apparatus does not exceed the Class B limits for radio noise emissions from digital apparatus set out in the Radio Interference Regulations of the Canadian Department of Communications.

This class B digital apparatus complies with Canadian ICES-003.

VCCI: Japan Compliance Statement

Class B ITE

この装置は、クラスB情報技術装置です。この装置は、家庭環境で使用することを目的としています。この装置がラジオやテレビジョン受信機に近接して使用されると、受信障害を引き起こすことがあります。

取扱説明書に従って正しい取り扱いをして下さい。

VCCI-B

This is a Class B product based on the standard of the VCCI Council. If this is used near a radio or television receiver in a domestic environment, it may cause radio interference. Install and use the equipment according to the instruction manual.

KC: Korea Warning Statement

B급 기기 (가정용 방송통신기자재)

이 기기는 가정용(B급) 전자파적합기기로서 주로 가정에서 사용하는 것을 목적으로 하며, 모든 지역에서 사용할 수 있습니다.

REACH

Complying with the REACH (Registration, Evaluation, Authorisation, and Restriction of Chemicals) regulatory framework, we published the chemical substances in our products at ASUS REACH website at <http://csr.asus.com/english/REACH.htm>.



DO NOT throw the motherboard in municipal waste. This product has been designed to enable proper reuse of parts and recycling. This symbol of the crossed out wheeled bin indicates that the product (electrical and electronic equipment) should not be placed in municipal waste. Check local regulations for disposal of electronic products.



DO NOT throw the mercury-containing button cell battery in municipal waste. This symbol of the crossed out wheeled bin indicates that the battery should not be placed in municipal waste.

ASUS Recycling/Takeback Services

ASUS recycling and takeback programs come from our commitment to the highest standards for protecting our environment. We believe in providing solutions for you to be able to responsibly recycle our products, batteries, other components as well as the packaging materials. Please go to <http://csr.asus.com/english/Takeback.htm> for detailed recycling information in different regions.

Google™ License Terms

Copyright© 2016 Google Inc. All Rights Reserved.

Licensed under the Apache License, Version 2.0 (the “License”); you may not use this file except in compliance with the License. You may obtain a copy of the License at:

<http://www.apache.org/licenses/LICENSE-2.0>

Unless required by applicable law or agreed to in writing, software distributed under the License is distributed on an “AS IS” BASIS, WITHOUT WARRANTIES OR CONDITIONS OF ANY KIND, either express or implied.

See the License for the specific language governing permissions and limitations under the License.

English AsusTek Inc. hereby declares that this device is in compliance with the essential requirements and other relevant provisions of CE Directives. Please see the CE Declaration of Conformity for more details.

Français AsusTek Inc. déclare par la présente que cet appareil est conforme aux critères essentiels et autres clauses pertinentes des directives européennes. Veuillez consulter la déclaration de conformité CE pour plus d'informations.

Deutsch AsusTek Inc. erklärt hiermit, dass dieses Gerät mit den wesentlichen Anforderungen und anderen relevanten Bestimmungen der CE-Richtlinien übereinstimmt. Weitere Einzelheiten entnehmen Sie bitte der CE-Konformitätserklärung.

Italiano AsusTek Inc. con la presente dichiara che questo dispositivo è conforme ai requisiti essenziali e alle altre disposizioni pertinenti alle direttive CE. Per maggiori informazioni fate riferimento alla dichiarazione di conformità CE.

Русский Компания ASUS заявляет, что это устройство соответствует основным требованиям и другим соответствующим условиям европейских директив. Подробную информацию, пожалуйста, смотрите в декларации соответствия.

Български С настоящото AsusTek Inc. декларира, че това устройство е в съответствие със съществениите изисквания и другите приложими постановления на директивите CE. Вижте CE декларацията за съвместимост за повече информация.

Hrvatski AsusTek Inc. ovim izjavljuje da je ovaj uređaj sukladan s bitnim zahtjevima i ostalim odgovarajućim odredbama CE direktiva. Više pojedinosti potražite u CE izvaji o sukladnosti.

Čeština Společnost AsusTek Inc. tímto prohlašuje, že toto zařízení splňuje základní požadavky a další příslušná ustanovení směrnice CE. Další podrobnosti viz Prohlášení o shodě CE.

Dansk AsusTek Inc. Erklærer hermed, at denne enhed er i overensstemmelse med hovedkravene and andre relevante bestemmelser i CE-direktivet. Du kan læse mere i CE-overensstemmelseserklæring.

Nederlands AsusTek Inc. verklaart hierbij dat dit apparaat compatibel is met de essentiële vereisten en andere relevante bepalingen van CE-richtlijnen. Raadpleeg de CE-verklaring van conformiteit voor meer details.

Eesti Käesolevaga kinnitab AsusTek Inc., et see seade vastab CE direktiivide oluliste nõuetele ja teisteles asjakohastele sätetele. Vt üksikasju CE vastavusdeklaratsioonist.

Suomi AsusTek Inc. vakuuttaa täten, että tämä laite on CE-direktiivien olennaisten vaatimusten ja muiden asiaan kuuluvien lisäysten mukainen. Katso lisätietoja CE-vaatimustenmukaisuusvakuutuksesta.

Ελληνικά Με το παρόν, η AsusTek Inc. Δηλώνει ότι αυτή η συσκευή συμμορφώνεται με τις θεμελιώδεις απαιτήσεις και άλλες σχετικές διατάξεις των Οδηγιών της ΕΕ. Για περισσότερες λεπτομέρειες ανατρέξτε στην Δήλωση Συμμόρφωσης ΕΕ.

Magyar Az AsusTek Inc. ezennel kijelenti, hogy a készülék megfelel a CE-irányelvek alapvető követelményeinek és ide vonatkozó egyéb rendelkezéseinek. További részletekért tekintse meg a CE-megfelelőségi nyilatkozatot.

Latviski Lidz ar šo AsusTek Inc. paziņo, ka šī ierīce atbilst būtiskajām prasībām un citiem saistošajiem nosacījumiem, kas norādīti CE direktīvā. Lai uzzinātu vairāk, skatiet CE Atbilstības deklarāciju.

Lietuvių Šiuo dokumentu bendrovė „AsusTek Inc.“ pareiškia, kad šis įrenginys atitinka pagrindinius CE direktyvų reikalavimus ir kitas susijusias nuostatas. Daugiau informacijos rasite CE atitikties deklaracijoje.

Norsk AsusTek Inc. erklærer herved at denne enheten er i samsvar med hovedsaklige krav og andre relevante forskrifter i CE-direktivet. Du finner mer informasjon i CE-samsvarserklæringen.

Polski Niniejszym AsusTek Inc. deklaruje, że to urządzenie jest zgodne z istotnymi wymaganiami oraz innymi powiązanymi zaleceniami Dyrektywy CE. W celu uzyskania szczegółów, sprawdź Deklarację zgodności CE.

Português A AsusTek Inc. declara que este dispositivo está em conformidade com os requisitos essenciais e outras disposições relevantes das Diretivas da CE. Para mais detalhes, consulte a Declaração de Conformidade CE.

Română Prin prezenta, AsusTek Inc. declară faptul că acest dispozitiv respectă cerințele esențiale și alte prevederi relevante ale directivelor CE. Pentru mai multe detalii, consultați declarația de conformitate CE.

Srpski AsusTek Inc. ovim izjavljuje da je ovaj uređaj u saglasnosti sa ključnim zahtjevima i drugim relevantnim odredbama CE Direktiva. Molimo vas, pogledajte CE Deklaraciju o uskladenosti za više detalja.

Slovensky Spoločnosť AsusTek Inc. týmto prehlasuje, že toto zariadenie vyhovuje príslušným požiadavkám a ďalším súvisiacim ustanoveniam smerníc ES. Viac podrobností si pozrite v prehlásení o zhode ES.

Slovenščina AsusTek Inc. tukaj izjavlja, da je ta naprava skladna s temeljnimi zahtevami in drugimi relevantnimi določili direktiv CE. Za več informacij glejte izjavo CE o skladnosti.

Español Por la presente, AsusTek Inc. declara que este dispositivo cumple los requisitos básicos y otras disposiciones relevantes de las directivas de la CE. Consulte la Declaración de conformidad de la CE para obtener más detalles.

Svenska AsusTek Inc. förklarar härmed att denna enhet är i överensstämmelse med de grundläggande kraven och andra relevanta bestämmelser i CE-direktiven. Se CE-försäkran om överensstämmelse för mer information.

Українська AsusTek Inc. заявляє, що цей пристрій відповідає основним вимогам відповідних Директив ЄС. Будь ласка, див. більше подробиць у Декларації відповідності нормам ЄС.

Türkçe AsusTek Inc., bu aygıtın temel gereksinimleri ve CE Yönergelerinin diğer ilgili koşullarına uyumlu olduğunu beyan eder. Daha fazla ayrıntı için lütfen CE Uygunluk Beyanına bakın.

Bosanski AsusTek Inc. ovim potvrđuje da je ovaj uređaj uskladen s osnovnim zahtjevima i drugim relevantnim propisima Direktiva EK. Za više informacija molimo pogledajte Deklaraciju o uskladenosti EK.

ASUS contact information

ASUSTeK COMPUTER INC.

Address 4F, No. 150, LI-TE Rd., PEITOU, TAIPEI 112, TAIWAN
Telephone +886-2-2894-3447
Fax +886-2-2890-7798
E-mail info@asus.com.tw
Web site www.asus.com/

Technical Support

Telephone +86-21-38429911
Fax +86-21-5866-8722, ext. 9101#
Online support <http://www.asus.com/tw/support/>

ASUS COMPUTER INTERNATIONAL (America)

Address 800 Corporate Way, Fremont, CA 94539, USA
Telephone +1-510-739-3777
Fax +1-510-608-4555
Web site <http://www.asus.com/us/>

Technical Support

Support fax +1-812-284-0883
Telephone +1-812-282-2787
Online support <http://www.service.asus.com/>

ASUS COMPUTER GmbH (Germany and Austria)

Address Harkort Str. 21-23, D-40880 Ratingen, Germany
Fax +49-2102-959911
Web site <http://www.asus.com/de>
Online contact <http://eu-rma.asus.com/sales>

Technical Support

Telephone +49-1805-010923
Support Fax +49-2102-9599-11
Online support <http://www.asus.com/de/support/>

